



Congratulations on purchasing NextStage Furniture products! You've made a wise investment. Our products will save you money and time, while helping you gain an edge in the extremely competitive real estate market.

**\*Warning\*** - NextStage Furniture products are not intended for use as actual furniture. They are for decorative purposes only. It is important that you take appropriate steps to insure that there are adequate warnings on the product that state the product is for decorative purposes only and is not intended to be used as actual furniture. You must place the warning tent cards that accompany this product on or near the product so that the general public is made aware that the product is for decorative purposes only and is not intended to be used as actual furniture. Further, you must display the caution sign that accompanies this product in a prominent place within the property.

**Product Assembly Instructions**

These easy to follow instructions will demonstrate the assembly steps for the NextStage Furniture Sofa, Loveseat, Oversized Chair, and Ottoman.

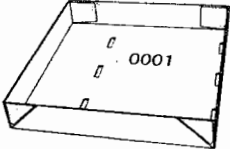
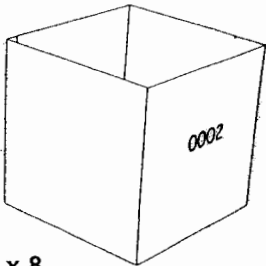
**Parts List**

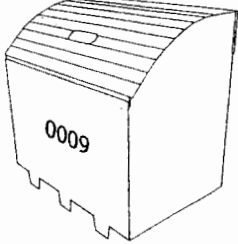
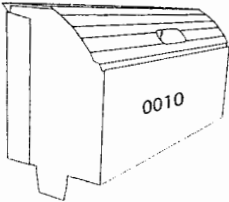
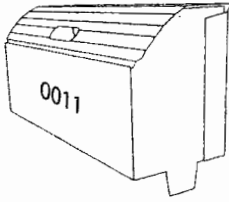
<p><b>Part #0001 - Top/Bottom Cover</b></p>  <p>Sofa x 16 Loveseat x 12 Oversized Chair x 8 Ottoman x 4</p>	<p><b>Part #0002 - 18" Tube</b></p>  <p>Sofa x 8 Loveseat x 6 Oversized Chair x 4 Ottoman x 2</p>	<p><b>Part #0003 - 18" Support</b></p>  <p>Sofa x 16 Loveseat x 12 Oversized Chair x 8 Ottoman x 4</p>
<p><b>Part #0009 - Sofa/Chair Back</b></p>  <p>Sofa x 4 Loveseat x 3 Oversized Chair x 2</p>	<p><b>Part #0010 - Right Arm Rest</b></p>  <p>Sofa x 1 Loveseat x 1 Oversized Chair x 1</p>	<p><b>Part #0011 - Left Arm Rest</b></p>  <p>Sofa x 1 Loveseat x 1 Oversized Chair x 1</p>
<p><b>Part #0027 - Sofa Slipcover</b></p> <p>Sofa x 1</p>	<p><b>Part #0028 - Loveseat Slipcover</b></p> <p>Loveseat x 1</p>	<p><b>Part #0029 - Oversized Chair Slipcover</b></p> <p>Oversized Chair x 1</p>
<p><b>Part #0030 - Ottoman Slipcover</b></p> <p>Ottoman x 1</p>		

## Step 1

**\*Hint\*** - When assembling your NextStage Furniture products for the first time, be careful to bend the corrugated parts only on the pre-scored folds.

Assemble the 18" Base Cubes by first opening the 18" Tube (Part #0002) so that it becomes square on the open ends. Place one Top/Bottom Cover (Part #0001) over one end of Part #0002. Turn the partially assembled cube over so that Part #0001 is on the floor. Diagonally place one 18" Support (Part #0003) into the open end of the cube with the notch toward the top of the cube. Diagonally place another 18" Support (Part #0003) into the cube with the notch toward the bottom of the cube. The notches on each support will interlock. Place another Top/Bottom Cover (Part #0001) over the open end of the cube. Repeat this process 8 times for the Sofa, 6 times for the Loveseat, 4 times for the Oversized Chair, or 2 times for the Ottoman. See figure below.

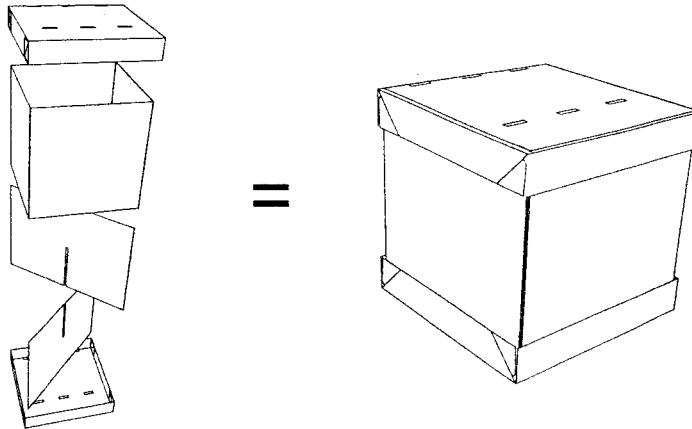

## Step 2

**\*Hint\*** - Assemble your furniture in the general area in which you wish to place the finished piece, but give yourself room to assemble. Once completed, you will easily be able to slide your NextStage Furniture into the exact position you desire.

Arrange the assembled cubes in the following patterns for the specified furniture piece. Be sure the slots on top of each row of cubes are aligned at the back of the furniture piece.

- Sofa – 2 rows of 4 Cubes
- Loveseat – 2 rows of 3 Cubes
- Oversized Chair – 2 rows of 2 Cubes
- Ottoman – 1 row of 2 Cubes

## Step 3

**\*Hint\*** - When assembling the furniture piece for the first time, you will find it helpful to pre-break all the scores across the top of the Sofa/Chair Backs (Part #0009), Right Arm Rest (Part #0010), and Left Arm Rest (Part #0011) by rolling the top of each part into a tight cylinder.

Erect the Sofa/Chair Backs (Part #0009) by opening the corrugated piece and tucking the top flap into the front of the part. Erect the Right Arm Rest (Part #0010) and Left Arm Rest (Part #0011) in a similar manner.

## Step 4

Insert the tabs on the Sofa/Chair Backs (Part #0009) into the 6 slots on top of each cube at the back of the furniture piece. Insert the tabs on the Right and Left Arm Rests (Part #0010 and Part #0011) into the same slots as the Sofa/Chair Back tabs on the far right and far left of the furniture piece. See the figures below.

**Sofa**

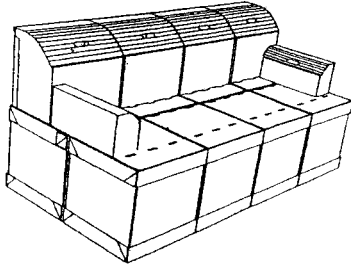

**Loveseat**

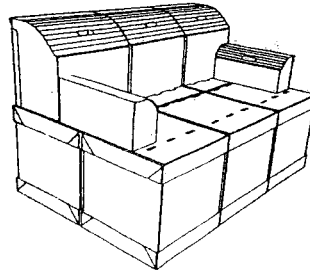

**Oversized Chair**

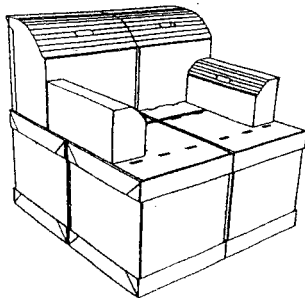

**Ottoman**

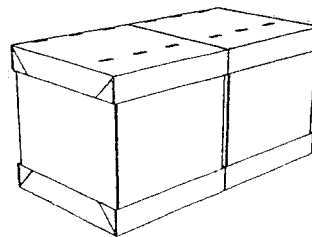

## Step 5

Slide the fitted slipcover (Part #0027, Part #0028, Part #0029, or Part #0030) over the entire erected and assembled corrugated structure.

**\*Hint\*** - Start by sliding the back of the slipcover over the back of the corrugated structure and work your way toward the front. You may need to realign the corrugated pieces under the slipcover after you have completed this step.

## Step 6

Use a steamer to remove any wrinkles in the slipcovers.

**\*Hint\*** - We have specifically chosen fabrics for our slipcovers that reduce the amount of wrinkling during storage, but some wrinkles are normal. Be careful not to steam any particular area on the slipcover to the point at which the corrugate parts under the slipcover become overly moist. Doing so could damage the corrugated part.

## Step 7

Accessorize your assembled NextStage Furniture.

**\*Hint\*** - The addition of throws and pillows is an excellent way to make your NextStage Furniture look its best. When not in use, we recommend always keeping your NextStage Furniture organized in the supplied weather resistant tote bags, and using the supplied plastic bag tags to label your products for easy identification.

If parts are missing or damaged please contact us at [info@NextStageFurniture.com](mailto:info@NextStageFurniture.com) or call (877)371-4551